

Product data sheet

Characteristics

XUYFLNEP60050

photo-electric sensor - XUY - fork - laser - pot +/- - 50X59mm - 12..24VDC - M8

Product availability : Non-Stock - Not normally stocked in distribution facility

Price* : 267.00 USD



Main

Range of product	OsiSense XU
Series name	Application
Electronic sensor type	Photo-electric sensor
Sensor name	XUY
Sensor design	Fork
Detection system	Thru beam
Emission	Infrared laser, modulated (class 1) conforming to IEC 825-1
Passage width	1.97 in (50 mm)
Passage depth	2.32 in (59 mm)
Material	Metal/plastic
Supply circuit type	DC
Wiring technique	4-wire
Discrete output type	PNP and NPN
Discrete output function	1 NO or 1 NC programmable
Electrical connection	1 male connector M8, 4 pins
Product specific application	Detection of reference marks Detection of transparent object Detection on vibrating rail Detection on small conveyor
[Sn] nominal sensing distance	1.97 in (50 mm)

Complementary

Enclosure material	Painted aluminium and polyamide/glass
Keypad type	Green
Minimum object diameter for detection	0 in (0.05 mm)
Type of output signal	Discrete
Output type	Solid state
Status LED	1 LED (red) adjustment mode and keypad locking 1 LED (yellow) output state
[Us] rated supply voltage	12...24 V DC with reverse polarity protection
Supply voltage limits	10...30 V DC

Switching capacity in mA	100 mA (overload and short-circuit protection)
Switching frequency	10 kHz
Voltage drop	< 2 V (closed state)
Current consumption	40 mA (no-load)
Load capacitance	330 nF
Time response	-20...20 µs
Setting-up	Sensitivity by numeric potentiometer
Product weight	0.42 lb(US) (0.19 kg)

Environment

Product certifications	CE cULus
Ambient air temperature for operation	-4...140 °F (-20...60 °C)
Ambient air temperature for storage	-22...176 °F (-30...80 °C)
Immunity to ambient light	10000 lux with natural light 5000 lux with incandescent bulb
Vibration resistance	7 gn, amplitude = +/- 0.75 mm (f = 10...55 Hz) conforming to IEC 60068-2-6
Shock resistance	30 gn (duration = 11 ms) conforming to IEC 60068-2-27
IP degree of protection	IP65 conforming to IEC 60529

Ordering and shipping details

Category	22481 - SENSORS, PHOTOELECTRIC
Discount Schedule	DS2
GTIN	003389119006934
Nbr. of units in pkg.	1
Package weight(Lbs)	0.20000000000000001
Returnability	N
Country of origin	FR

Offer Sustainability

RoHS (date code: YYWW)	Compliant - since 0727 - Schneider Electric declaration of conformity Schneider Electric declaration of conformity
California proposition 65	WARNING: This product can expose you to chemicals including:
----- Substance 1	Diisononyl phthalate (DINP), which is known to the State of California to cause cancer, and
----- Substance 2	Di-isodecyl phthalate (DIDP), which is known to the State of California to cause birth defects or other reproductive harm.
----- More information	For more information go to www.p65warnings.ca.gov

Contractual warranty

Warranty period	18 months
-----------------	-----------

Dimensions

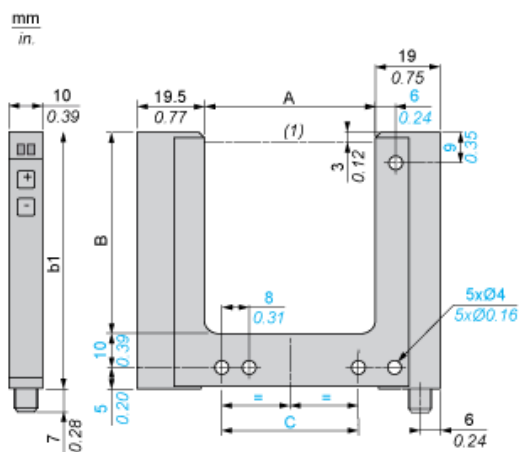

(1) Optical axis

Dimensions in mm

A	B	b1	C
50	59	74	40

Dimensions in in.

A	B	b1	C
1.97	2.32	2.91	1.57

Wiring Schemes

M8 Connector

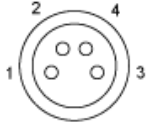

- 1 : BN: Brown
- 2 : WH: White
- 3 : BU: Blue
- 4 : BK: Black

4-Wire, PNP/NPN Outputs

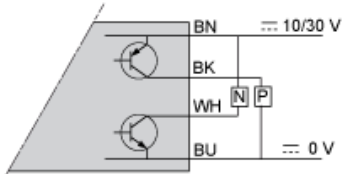

- BN : Brown
- WH : White
- BK : Black
- BU : Blue