

# Product data sheet

## Characteristics

# XUK0AKSAL10

photo-electric sensor - XUK - multi - Sn 0..30m - 12..24VDC - cable 10m

Product availability : Non-Stock - Not normally stocked in distribution facility

Price\*\* : 127.00 USD



### Main

Range of product	OsiSense XU
Series name	General purpose multimode
Electronic sensor type	Photo-electric sensor
Sensor name	XUK
Sensor design	Compact 50 x 50
Detection system	Multimode
Material	Plastic
Type of output signal	Discrete
Supply circuit type	DC
Wiring technique	3-wire
Discrete output type	PNP or NPN
Discrete output function	1 NO or 1 NC programmable
Electrical connection	Cable
Cable length	32.81 ft (10 m)
Product specific application	-
Emission	Infrared diffuse Infrared diffuse with background suppression Infrared thru beam Red polarised reflex
[Sn] nominal sensing distance	0.92 ft (0.28 m) diffuse with background suppression 2.62 ft (0.8 m) diffuse 13.12 ft (4 m) polarised reflex need reflector XUZC50 98.43 ft (30 m) thru beam need a transmitter XUK0AKSAL10T

### Complementary

Enclosure material	PBT
Lens material	PMMA
Maximum sensing distance	114.83 ft (35 m) thru beam 0.92 ft (0.28 m) diffuse with background suppression 3.94 ft (1.2 m) diffuse 18.7 ft (5.7 m) polarised reflex
Output type	Solid state

Add on output	With alarm output, <= 50 mA with overload and short-circuit protection
Wire insulation material	PvR
Status LED	1 LED (green) supply 1 LED (red) instability 1 LED (yellow) output state
[Us] rated supply voltage	12...24 V DC with reverse polarity protection
Supply voltage limits	10...36 V DC
Switching capacity in mA	<= 100 mA (overload and short-circuit protection)
Switching frequency	<= 250 Hz
Voltage drop	<= 1.5 V (closed state)
Current consumption	<= 35 mA (no-load)
Delay first up	< 200 ms
Delay response	< 2 ms
Delay recovery	< 2 ms
Setting-up	Self-teaching
Depth	1.97 in (50 mm)
Height	1.97 in (50 mm)
Width	0.71 in (18 mm)

## Environment

Product certifications	CE UL CSA
Ambient air temperature for operation	-13...131 °F (-25...55 °C)
Ambient air temperature for storage	-40...158 °F (-40...70 °C)
Vibration resistance	7 gn, amplitude = +/- 1.5 mm (f = 10...55 Hz) conforming to IEC 60068-2-6
Shock resistance	30 gn (duration = 11 ms) conforming to IEC 60068-2-27
IP degree of protection	IP65 double insulation conforming to IEC 60529

## Ordering and shipping details

Category	22481 - SENSORS, PHOTOELECTRIC
Discount Schedule	DS2
GTIN	003389110565782
Nbr. of units in pkg.	1
Package weight(Lbs)	0.4500000000000001
Returnability	N
Country of origin	ID

## Offer Sustainability

RoHS (date code: YYWW)	Compliant - since 0903 - Schneider Electric declaration of conformity <a href="#">Schneider Electric declaration of conformity</a>
Product environmental profile	Available
Product end of life instructions	Available
California proposition 65	WARNING: This product can expose you to chemicals including:
----- Substance 1	Diisononyl phthalate (DINP), which is known to the State of California to cause cancer, and
----- Substance 2	Di-isodecyl phthalate (DIDP), which is known to the State of California to cause birth defects or other reproductive harm.
----- More information	For more information go to <a href="http://www.p65warnings.ca.gov">www.p65warnings.ca.gov</a>

## Contractual warranty

Warranty period	18 months
-----------------	-----------

Dimensions

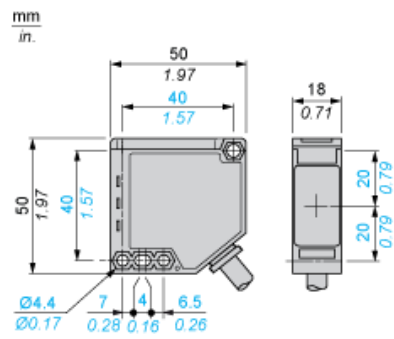

---

Wiring Schemes

---

PNP Output

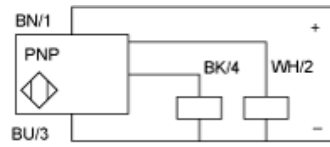

(+) BN : Brown  
(-) BU : Blue  
(OUT/Output) BK : Black  
(Alarm) WH : White

NPN Output

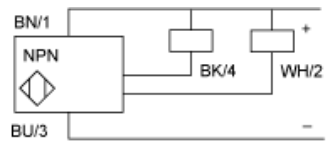

(+) BN : Brown  
(-) BU : Blue  
(OUT/Output) BK : Black  
(Alarm) WH : White

Detection Curves

With Thru-beam Accessory (Thru-beam)

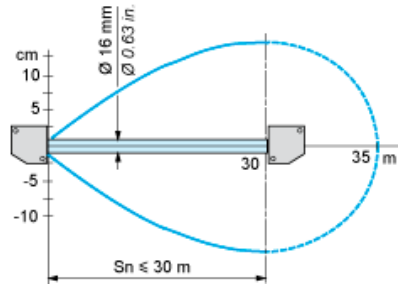

Without Accessory (Diffuse)

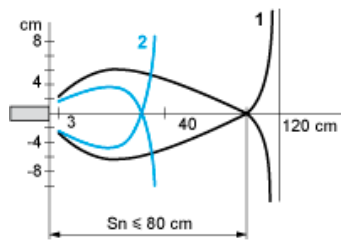

- 1 : White 90%
  - 2 : Grey 18%
- Object 10 x 10 cm

Without Accessory (Diffuse with background suppression)

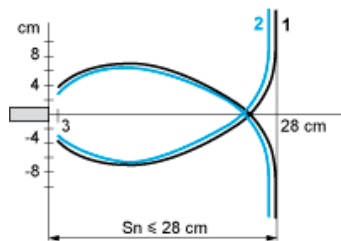

- 1 : White 90%
  - 2 : Grey 18%
- Object 10 x 10 cm

With reflector (Polarised reflex)

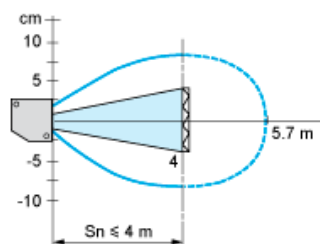

With reflector XUZC50

## Variation of Usable Sensing Distance $S_u$ (Without accessory, with adjustable background suppression)

Teach Mode at Minimum

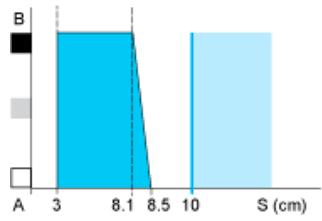

Teach Mode at Maximum

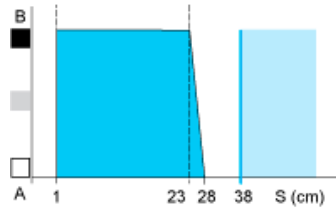

- (1) Black
- (2) Grey
- (3) White
- (4) Sensing range
- (5) Non sensing zone (matt surfaces)

A-B : Object reflection coefficient

- (1) Black 6%
- (2) Grey 18%
- (3) White 90%
- (4) Sensing range
- (5) Non sensing zone (matt surfaces)