

Product data sheet

Characteristics

XS1N30PC410D

inductive sensor XS1 M30 - L53mm - brass - Sn10mm - 12..24VDC - M12

Product availability : Non-Stock - Not normally stocked in distribution facility



Price* : 99.00 USD

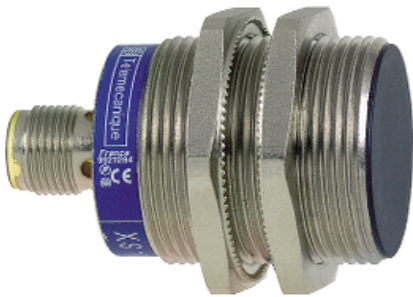

Main

Range of product	OsiSense XS
Series name	General purpose
Sensor type	Inductive proximity sensor
Device application	Mobile equipment
Sensor name	XS1
Sensor design	Cylindrical M30
Size	53 mm
Body type	Fixed
Detector flush mounting acceptance	Flush mountable
Material	Metal
Type of output signal	Discrete
Wiring technique	4-wire
[Sn] nominal sensing distance	0.39 in (10 mm)
Discrete output function	1 NO + 1 NC
Output circuit type	DC
Discrete output type	PNP
Electrical connection	4 pins M12 male connector
[Us] rated supply voltage	12...24 V DC with reverse polarity protection
Switching capacity in mA	<= 200 mA with overload and short-circuit protection
IP degree of protection	IP67 IP65 conforming to IEC 60529 IP69K conforming to DIN 40050

Complementary

Safety level	SILCL 2 conforming to IEC 62061 PL = d conforming to EN/ISO 13849-1 SIL 2 conforming to EN/IEC 61508
--------------	--

Safety reliability data	MTTFd = 1810 years PFHd = 62.9E-9 1/h SFF = 92 % DC = 74 % with appropriate safety controller
Service life	20 yr
Thread type	M30 x 1.5
Detection face	Frontal
Front material	PPS
Enclosure material	Nickel plated brass
Operating zone	0...0.31 in (0...8 mm)
Differential travel	1...15% of Sr
Status LED	1 LED yellow output state
Supply voltage limits	9...36 V DC
Switching frequency	<= 1000 Hz
Voltage drop	<= 2 V at closed state
Current consumption	0...10 mA at no-load
Delay first up	<= 5 ms
Delay response	<= 0.3 ms
Delay recovery	<= 0.7 ms
Marking	CE
Threaded length	1.3 in (33 mm)
Height	1.18 in (30 mm)
Length	2.13 in (54 mm)
Product weight	0.22 lb(US) (0.1 kg)

Environment

Standards	EN/ISO 13849-1 IEC 62061
Product certifications	CSA TÜV UL E2
Ambient air temperature for operation	-13...158 °F (-25...70 °C)
Ambient air temperature for storage	-40...185 °F (-40...85 °C)
Vibration resistance	25 gn amplitude = +/- 2 mm (f = 10...55 Hz) conforming to IEC 60068-2-6
Shock resistance	50 gn 11 ms conforming to IEC 60068-2-27

Ordering and shipping details

Category	22486 - SENSORS, PROXIMITY
Discount Schedule	DS2
GTIN	00785901081807
Nbr. of units in pkg.	1
Package weight(Lbs)	0.28000000000000003
Returnability	N
Country of origin	FR

Offer Sustainability

Sustainable offer status	Green Premium product
RoHS (date code: YYWW)	Compliant - since 0811 - Schneider Electric declaration of conformity Schneider Electric declaration of conformity
REACH	Reference not containing SVHC above the threshold Reference not containing SVHC above the threshold
Product environmental profile	Available
Product end of life instructions	Available

California proposition 65	WARNING: This product can expose you to chemicals including:
- - - - - Substance 1	Diisononyl phthalate (DINP), which is known to the State of California to cause cancer, and
- - - - - Substance 2	Di-isodecyl phthalate (DIDP), which is known to the State of California to cause birth defects or other reproductive harm.
- - - - - More information	For more information go to www.p65warnings.ca.gov

Contractual warranty

Warranty period	18 months
-----------------	-----------

Dimensions

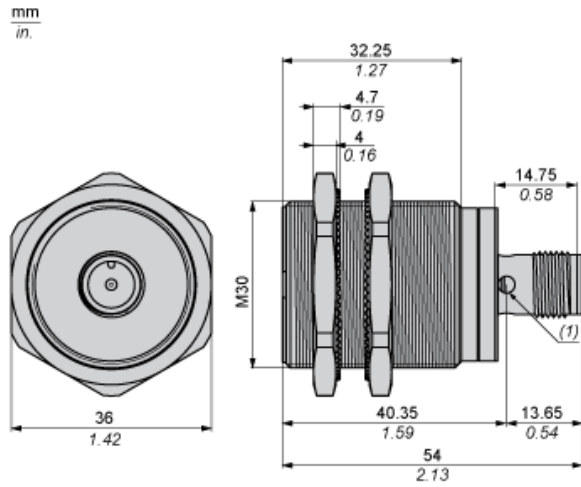

(1) LED

Minimum Mounting Distances

Side by side

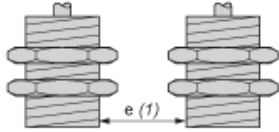

$e (1) \geq 20 \text{ mm}/0.79 \text{ in}$

Face to face

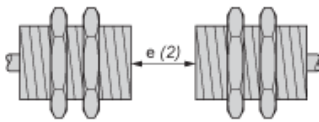

$e (2) \geq 120 \text{ mm}/4.72 \text{ in}$

Facing a metal object

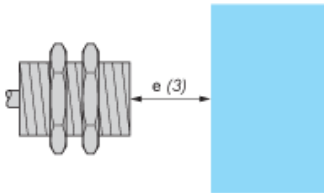

$e (3) \geq 30 \text{ mm}/1.18 \text{ in}$.

Wiring Schemes

M12 connector



PNP 4-wire

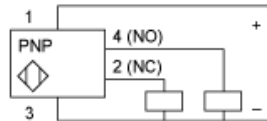

Performance Curves

Standard Steel Target : 30x30x1 mm

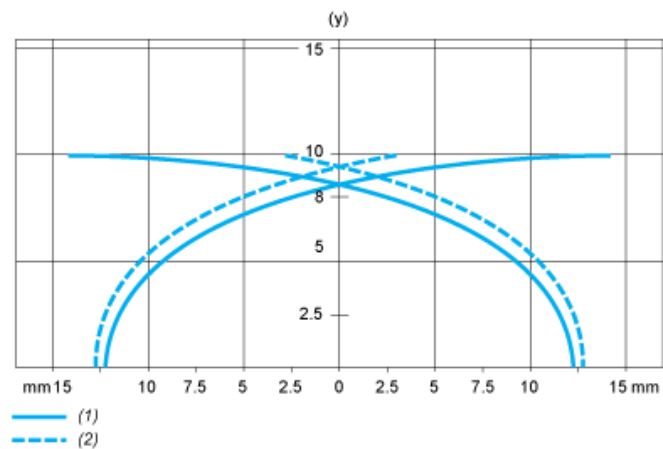

- (1) Pick-up points
- (2) Drop-out points (object approaching from the side)
- (y) Sensing distance in mm