

Product data sheet

Characteristics

XS1M18MA250L1

inductive sensor XS1 M18 - L60mm - brass - Sn5mm - 24..240VAC/DC - cable 5m

Product availability : Non-Stock - Not normally stocked in distribution facility



Price* : 158.16 USD



Main

Range of product	OsiSense XS
Series name	General purpose
Sensor type	Inductive proximity sensor
Wiring configuration	2-wire
Output circuit type	AC/DC
Protection type	Short-circuit protection
Device application	2-wire DC short-circuit protection
Sensor name	XS1
Sensor design	Cylindrical M18
Size	60 mm
Body type	Fixed
Detector flush mounting acceptance	Flush mountable
Material	Metal
Type of output signal	Discrete
Wiring technique	2-wire
[Sn] nominal sensing distance	0.2 in (5 mm)
Discrete output function	1 NO
Electrical connection	Cable
Cable length	16.4 ft (5 m)
[Us] rated supply voltage	24...210 V DC 24...240 V AC 50/60 Hz
Switching capacity in mA	5...200 mA DC with overload and short-circuit protection 5...300 mA AC with overload and short-circuit protection
IP degree of protection	IP68 double insulation conforming to IEC 60529

Disclaimer: This documentation is not intended as a substitute for and is not to be used for determining suitability or reliability of these products for specific user applications

Complementary

Thread type	M18 x 1
Detection face	Frontal
Front material	PPS
Enclosure material	Nickel plated brass
Operating zone	0...0.16 in (0...4 mm)
Differential travel	1...15% of Sr
Cable composition	2 x 0.34 mm ²
Wire insulation material	PvR
Status LED	1 LED green supply on 1 LED yellow output state
Supply voltage limits	20...264 V AC/DC
Residual current	<= 1.5 mA open state
Switching frequency	<= 2000 Hz DC <= 25 Hz AC
Voltage drop	<= 5.5 V at closed state
Delay first up	<= 70 ms
Delay response	<= 2 ms
Delay recovery	<= 4 ms
Marking	CE
Threaded length	2.01 in (51 mm)
Height	0.71 in (18 mm)
Length	2.36 in (60 mm)
Product weight	0.26 lb(US) (0.12 kg) 0.53 lb(US) (0.24 kg)

Environment

Product certifications	CCC CSA UL
Ambient air temperature for operation	-13...158 °F (-25...70 °C)
Ambient air temperature for storage	-40...185 °F (-40...85 °C)
Vibration resistance	25 gn amplitude = +/- 2 mm (f = 10...55 Hz) conforming to IEC 60068-2-6
Shock resistance	50 gn 11 ms conforming to IEC 60068-2-27

Ordering and shipping details

Category	22486 - SENSORS, PROXIMITY
Discount Schedule	DS2
GTIN	00785901915690
Nbr. of units in pkg.	1
Package weight(Lbs)	0.5899999999999999
Returnability	N
Country of origin	FR

Offer Sustainability

Sustainable offer status	Green Premium product
RoHS (date code: YYWW)	Compliant - since 0808 - Schneider Electric declaration of conformity Schneider Electric declaration of conformity
REACH	Reference not containing SVHC above the threshold Reference not containing SVHC above the threshold
Product environmental profile	Available
Product end of life instructions	Available

California proposition 65	WARNING: This product can expose you to chemicals including:
- - - - - Substance 1	Diisononyl phthalate (DINP), which is known to the State of California to cause cancer, and
- - - - - Substance 2	Di-isodecyl phthalate (DIDP), which is known to the State of California to cause birth defects or other reproductive harm.
- - - - - More information	For more information go to www.p65warnings.ca.gov

Contractual warranty

Warranty period	18 months
-----------------	-----------

Dimensions

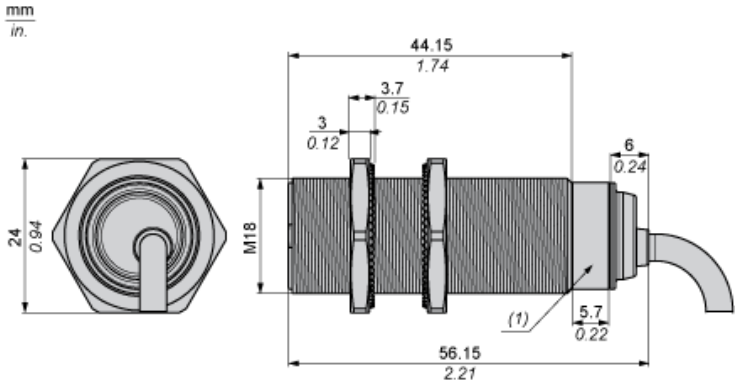

(1) LED

Minimum Mounting Distances

Side by side

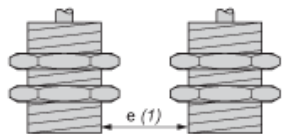

$e (1) \geq 10 \text{ mm}/0.39 \text{ in.}$

Face to face

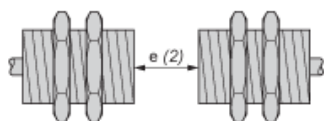

$e (2) \geq 60 \text{ mm}/2.36 \text{ in.}$

Facing a metal object

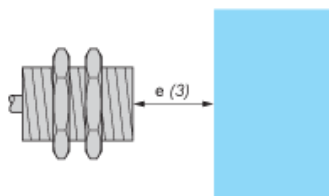

$e (3) \geq 15 \text{ mm}/0.60 \text{ in}$

Mounting

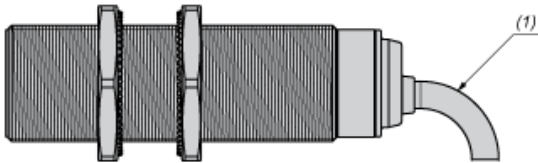

(1) Bending cable: 4 x external cable diameter

Wiring Schemes

2-Wire AC or DC

NO output

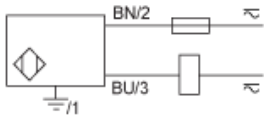

BU : Blue
BN : Brown

Performance Curves

Standard Steel Target : 18x18x1 mm

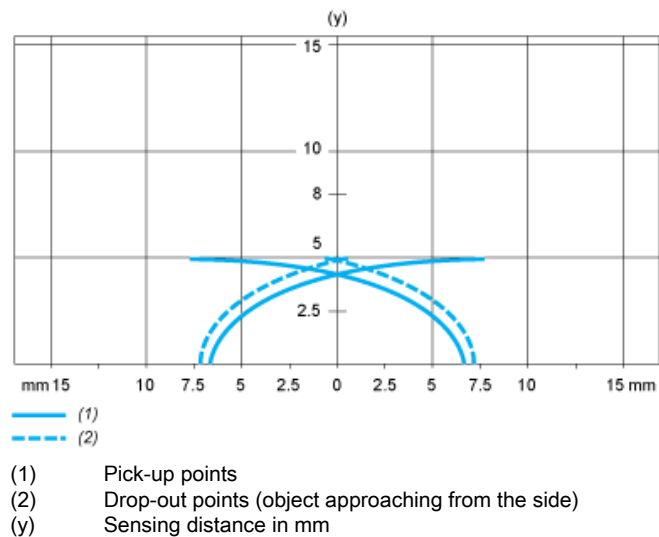

XS1M18MA250L1 is replaced by:



Inductive sensors XS XS618B1MAL5

inductive sensor XS6 M18 - L62mm - brass - Sn8mm - 24..240VAC/DC - cable 5m

Qty 1

Reason for Substitution: End of life | Substitution date: 01 January 2017