

Main

Range of product	Lexium PAS E
Product or component type	Portal axis
Product specific application	For 1 direction
Load position	On carriage
Drive type	Toothed belt
Guide type	Ball

Complementary

Operating position	Horizontal
Typical payload	26.46 lb(US) (12 kg)
Distance per revolution	6.1 in (155 mm)
Operating force	<= 800 N for Fx <= 2810 N for Fy <= 2810 N for Fz
Maximum speed	6.56 ft/s (2 m/s)
Maximum acceleration	49.21 ft/s ² (15 m/s ²)
Max. drive torque	<= 4 N.m
Max. torque	<= 5 N.m for Mx <= 11 N.m for My <= 17 N.m for Mz
Stroke	84.65 in (2150 mm)
Product weight	16.53 lb(US) (7.5 kg) at 0 stroke with carriage and motor 2.2 lb(US) (1 kg) of carriage 75.84 lb(US) (34.4 kg) total
Repeat accuracy	+/- 0.05 mm
Outer dimension	60 x 60 mm
Service life	30000 km
Associated module	BMH0702P06A2A servo motor (supplied) PLE60 planetary gearbox, reduction ratio: 5:1 (supplied) LXM32.D12N4 servo drive (not supplied)

Offer Sustainability

RoHS (date code: YYWW)	Compliant - since 1501 - Schneider Electric declaration of conformity
------------------------	---

 Schneider Electric declaration of conformity

REACH

Reference not containing SVHC above the threshold
Reference not containing SVHC above the threshold

Contractual warranty

Warranty period

18 months

Size Characteristics

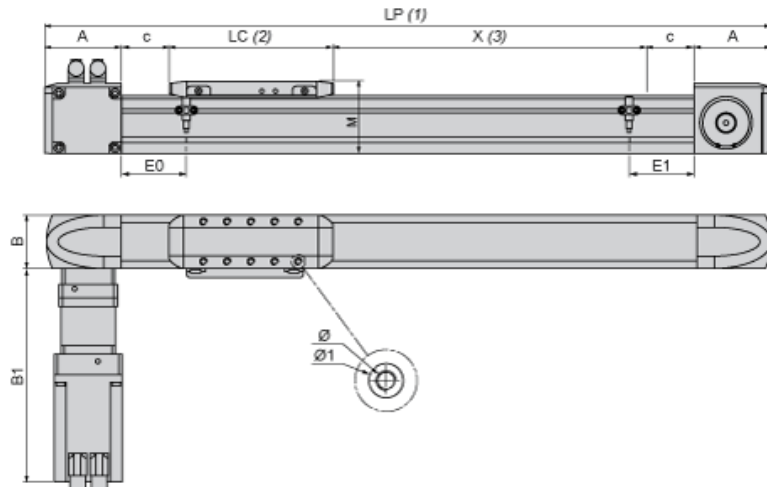

- (1) LP : total length of axis
- (2) LC : length of carriage
- (3) X : Stroke, refer to product characteristics.

A	mm	80
	in.	3.15
B	mm	60
	in.	2.36
B1	mm	278
	in.	10.94
c	mm	15
	in.	0.59
E0	mm	33
	in.	1.30
E1	mm	33
	in.	1.30
LC	mm	206
	in.	8.11
LP	mm	= 190 + LC + X
	in.	= 7.48 + LC + X
M	mm	75
	in.	2.95
Ø	mm	M5 X 12
	in.	M5 X 0.47
Ø1	mm	8 ^{H7} X 2.1
	in.	8 ^{H7} X 0.08

Servo Motor Mounting

Standard servo motor mounting



Servo motor mounted on the left

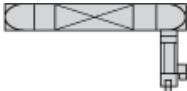

Axis Positioning Time as a Function of the Stroke

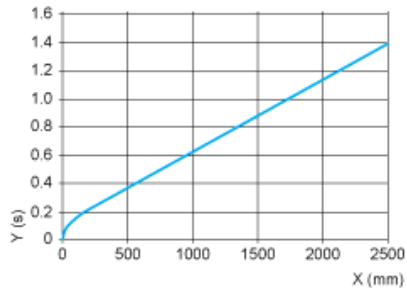

X : Stroke
Y : Positioning time

Forces and Torques Exerted on the Lexium PAS E Portal Axis

