

Product data sheet

Characteristics

ATV212HU55N4

variable speed drive ATV212 - 5.5kW - 7.5hp - 480V - 3ph - EMC - IP21

Product availability : Stock - Normally stocked in distribution facility



Price* : 795.00 USD



Main

Range of product	Altivar 212
Product or component type	Variable speed drive
Device short name	ATV212
Product destination	Asynchronous motors
Product specific application	Pumps and fans in HVAC
Assembly style	With heat sink
Phase	3 phases
Motor power kW	5.5 kW
Motor power hp	7.5 hp
[Us] rated supply voltage	380...480 V - 15...10 %
Supply voltage limits	323...528 V
Supply frequency	50...60 Hz - 5...5 %
Network frequency	47.5...63 Hz
EMC filter	Class C2 EMC filter integrated
Line current	8.6 A 480 V 10.9 A 380 V

Complementary

Apparent power	9.1 kVA 380 V
Prospective line I _{sc}	22 kA
Continuous output current	12 A 380 V 12 A 460 V
Maximum transient current	13.2 A 60 s
Speed drive output frequency	0.5...200 Hz
Nominal switching frequency	12 kHz
Switching frequency	12...16 kHz with derating factor 6...16 kHz adjustable

Speed range	1...10
Speed accuracy	+/- 10 % of nominal slip 0.2 Tn to Tn
Torque accuracy	+/- 15 %
Transient overtorque	120 % of nominal motor torque +/- 10 % 60 s
Asynchronous motor control profile	Voltage/frequency ratio, 2 points Voltage/frequency ratio, 5 points Flux vector control without sensor, standard Voltage/frequency ratio - Energy Saving, quadratic U/f Voltage/frequency ratio, automatic IR compensation (U/f + automatic Uo)
Regulation loop	Adjustable PI regulator
Motor slip compensation	Adjustable Automatic whatever the load Not available in voltage/frequency ratio motor control
Local signalling	1 LED red DC bus energized
Output voltage	<= power supply voltage
Isolation	Electrical between power and control
Type of cable	IEC cable without mounting kit 1 113 °F (45 °C) copper 90 °C XLPE/EPR IEC cable without mounting kit 1 45 °C copper 70 °C PVC UL 508 cable with UL Type 1 kit 3 40 °C copper 75 °C PVC
Electrical connection	Terminal 0 in ² (2.5 mm ²) AWG 14 VIA, VIB, FM, FLA, FLB, FLC, RY, RC, F, R, RES Terminal 6 mm ² AWG 10 L1/R, L2/S, L3/T
Tightening torque	11.5 lbf.in (1.3 N.m) 11.5 lb.in L1/R, L2/S, L3/T 0.6 N.m VIA, VIB, FM, FLA, FLB, FLC, RY, RC, F, R, RES
Supply	Internal supply for reference potentiometer (1 to 10 kOhm) 10.5 V DC +/- 5 % <= 10 A overload and short-circuit protection Internal supply 24 V DC 21...27 V <= 200 A overload and short-circuit protection
Analogue input number	2
Analogue input type	Switch-configurable voltage VIA 0...10 V DC 24 V max 30000 Ohm 10 bits Configurable voltage VIB 0...10 V DC 24 V max 30000 Ohm 10 bits Configurable PTC probe VIB 0...6 probes 1500 Ohm Switch-configurable current VIA 0...20 mA 250 Ohm 10 bits
Sampling duration	2 ms +/- 0.5 ms F discrete 2 ms +/- 0.5 ms R discrete 2 ms +/- 0.5 ms RES discrete 3.5 ms +/- 0.5 ms VIA analog 22 ms +/- 0.5 ms VIB analog
Response time	2 ms +/- 0.5 ms FM analog 7 ms +/- 0.5 ms FLA, FLC discrete 7 ms +/- 0.5 ms FLB, FLC discrete 7 ms +/- 0.5 ms RY, RC discrete
Accuracy	+/- 0.6 % VIA for a temperature variation 60 °C +/- 0.6 % VIB for a temperature variation 60 °C +/- 1 % FM for a temperature variation 60 °C
Linearity error	+/- 0.15 % of maximum value input VIA +/- 0.15 % of maximum value input VIB +/- 0.2 % output FM
Analogue output number	1
Analogue output type	Switch-configurable voltage FM 0...10 V DC 7620 Ohm 10 bits Switch-configurable current FM 0...20 mA 970 Ohm 10 bits
Discrete output number	2
Discrete output type	Configurable relay logic FLA, FLC NO 100000 cycles Configurable relay logic FLB, FLC NC 100000 cycles Configurable relay logic RY, RC NO 100000 cycles
Minimum switching current	3 mA 24 V DC configurable relay logic
Maximum switching current	5 A 250 V AC resistive cos phi = 1 L/R = 0 ms FL, R 5 A 30 V DC resistive cos phi = 1 L/R = 0 ms FL, R 2 A 250 V AC inductive cos phi = 0.4 L/R = 7 ms FL, R 2 A 30 V DC inductive cos phi = 0.4 L/R = 7 ms FL, R
Discrete input type	Programmable F 24 V DC level 1 PLC 4700 Ohm Programmable R 24 V DC level 1 PLC 4700 Ohm Programmable RES 24 V DC level 1 PLC 4700 Ohm
Discrete input logic	Positive logic (source) F, R, RES <= 5 V >= 11 V Negative logic (sink) F, R, RES >= 16 V <= 10 V

Acceleration and deceleration ramps	Automatic based on the load Linear adjustable separately from 0.01 to 3200 s
Braking to standstill	By DC injection
Protection type	Motor phase break motor Break on the control circuit drive Thermal power stage drive Overvoltages on the DC bus drive Against exceeding limit speed drive Against input phase loss drive With PTC probes motor Input phase breaks drive Line supply overvoltage and undervoltage drive Line supply undervoltage drive Overcurrent between output phases and earth drive Overheating protection drive Short-circuit between motor phases drive Thermal protection motor
Dielectric strength	3535 V DC between earth and power terminals 5092 V DC between control and power terminals
Insulation resistance	>= 1 MOhm 500 V DC for 1 minute
Frequency resolution	0.024/50 Hz analog input 0.1 Hz display unit
Communication port protocol	APOGEE FLN BACnet LonWorks METASYS N2 Modbus
Connector type	1 RJ45 1 open style
Physical interface	2-wire RS 485
Transmission frame	RTU
Transmission rate	9600 bps or 19200 bps
Data format	8 bits, 1 stop, odd even or no configurable parity
Type of polarization	No impedance
Number of addresses	1...247
Communication service	Monitoring inhibitible Read device identification (43) Read holding registers (03) 2 words maximum Time out setting from 0.1 to 100 s Write multiple registers (16) 2 words maximum Write single register (06)
Option card	Communication card LonWorks
Operating position	Vertical +/- 10 degree
Width	5.59 in (142 mm)
Height	7.24 in (184 mm)
Depth	5.91 in (150 mm)
Product weight	7.39 lb(US) (3.35 kg)
Power dissipation in W	215 W
Air flow	19549.08 Gal/hr(US) (74 m3/h)
Functionality	Mid
Specific application	HVAC
IP degree of protection	IP21
Variable speed drive application selection	Building - HVAC : compressor for scroll Building - HVAC : fan Building - HVAC : pump
Motor power range AC-3	4...6 kW at 380...440 V 3 phases 4...6 kW at 480...500 V 3 phases
Motor starter type	Variable speed drive

Environment

Electromagnetic compatibility	Conducted radio-frequency immunity test level 3 IEC 61000-4-6 Voltage dips and interruptions immunity test IEC 61000-4-11
-------------------------------	--

1.2/50 µs - 8/20 µs surge immunity test level 3 IEC 61000-4-5
 Electrical fast transient/burst immunity test level 4 IEC 61000-4-4
 Electrostatic discharge immunity test level 3 IEC 61000-4-2
 Radiated radio-frequency electromagnetic field immunity test level 3 IEC 61000-4-3

Pollution degree	3 IEC 61800-5-1
IP degree of protection	IP20 on upper part without blanking plate on cover EN/IEC 61800-5-1 IP20 on upper part without blanking plate on cover EN/IEC 60529 IP21 EN/IEC 61800-5-1 IP21 EN/IEC 60529 IP41 on upper part EN/IEC 61800-5-1 IP41 on upper part EN/IEC 60529
Vibration resistance	1 gn 13...200 Hz EN/IEC 60068-2-8 1.5 mm 3...13 Hz EN/IEC 60068-2-6
Shock resistance	15 gn 11 ms IEC 60068-2-27
Environmental characteristic	Classes 3C1 IEC 60721-3-3 Classes 3S2 IEC 60721-3-3
Noise level	51 dB 86/188/EEC
Operating altitude	3280.84...9842.52 ft (1000...3000 m) limited to 2000 m for the Corner Grounded distribution network with current derating 1 % per 100 m <= 3280.84 ft (1000 m) without derating
Relative humidity	5...95 % without condensation IEC 60068-2-3 5...95 % without dripping water IEC 60068-2-3
Ambient air temperature for operation	14...104 °F (-10...40 °C) without derating > 104...122 °F (> 40...50 °C) with derating factor
Ambient air temperature for storage	-13...158 °F (-25...70 °C)
Standards	EN 55011 class A group 1 EN 61800-3 EN 61800-3 category C2 EN 61800-3 category C3 EN 61800-3 environments 1 category C1 EN 61800-3 environments 1 category C2 EN 61800-3 environments 1 category C3 EN 61800-3 environments 2 category C1 EN 61800-3 environments 2 category C2 EN 61800-3 environments 2 category C3 EN 61800-5-1 IEC 61800-3 IEC 61800-3 category C2 IEC 61800-3 category C3 IEC 61800-3 environments 1 category C1 IEC 61800-3 environments 1 category C2 IEC 61800-3 environments 1 category C3 IEC 61800-3 environments 2 category C1 IEC 61800-3 environments 2 category C2 IEC 61800-3 environments 2 category C3 IEC 61800-5-1 UL Type 1
Product certifications	CSA C-Tick NOM 117 UL
Marking	CE

Ordering and shipping details

Category	22157 - ATV212 1 - 25 HP 460 VOLT
Discount Schedule	CP4D
GTIN	00785901917298
Nbr. of units in pkg.	1
Package weight(Lbs)	6.8600000000000003
Returnability	Y
Country of origin	ID

Offer Sustainability

Sustainable offer status	Green Premium product
--------------------------	-----------------------

RoHS (date code: YYWW)	Compliant - since 1051 - Schneider Electric declaration of conformity Schneider Electric declaration of conformity
REACH	Reference not containing SVHC above the threshold Reference not containing SVHC above the threshold
Product environmental profile	Available Product Environmental Profile
Product end of life instructions	Available
California proposition 65	WARNING: This product can expose you to chemicals including:
----- Substance 1	Lead and lead compounds, which is known to the State of California to cause cancer and birth defects or other reproductive harm.
----- Substance 2	Bisphenol A (BPA), which is known to the State of California to cause birth defects or other reproductive harm.
----- More information	For more information go to www.p65warnings.ca.gov

Contractual warranty

Warranty period	18 months
-----------------	-----------

Dimensions

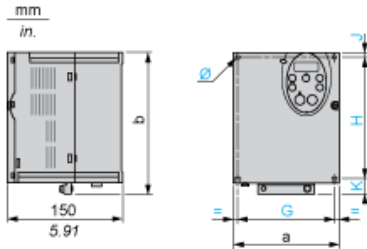

Dimensions in mm

ATV212H	a	b	G	H	J	K	Ø
075M3X...U22M3X 075N4...U22N4	107	143	93	121.5	5	16.5	2 x Ø5
U30M3X, U40M3X U30N4...U55N4	142	184	126	157	6.5	20.5	4 x Ø5

Dimensions in in.

ATV212H	a	b	G	H	J	K	Ø
075M3X...U22M3X 075N4...U22N4	4.21	5.63	3.66	4.78	0.20	0.65	2 x Ø0.20
U30M3X, U40M3X U30N4...U55N4	5.59	7.24	4.96	6.18	0.26	0.81	4 x Ø0.20

Plate for EMC mounting (supplied with the drive)

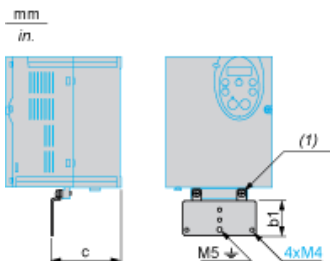

(1) 2 x M5 screws

Dimensions in mm

ATV212H	b1	c
075M3X...U22M3X 075N4...U22N4	49	67.3
U30M3X, U40M3X U30N4...U55N4	48	88.8

Dimensions in in.

ATV212H	b1	c
075M3X...U22M3X 075N4...U22N4	1.93	2.65
U30M3X, U40M3X U30N4...U55N4	1.89	3.50

Mounting Recommendations

Clearance

Depending on the conditions in which the drive is to be used, its installation will require certain precautions and the use of appropriate accessories.

Install the unit vertically:

- Do not place it close to heating elements.
- Leave sufficient free space to ensure that the air required for cooling purposes can circulate from bottom to the top of the unit.

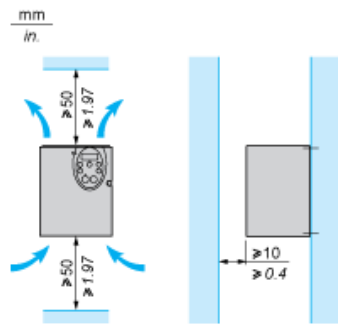

Mounting Types

Type A mounting

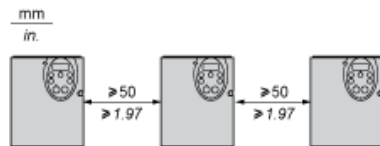

Type B mounting

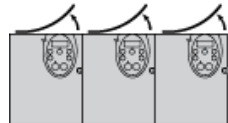

Type C mounting

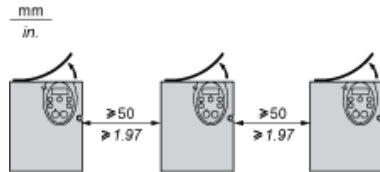

By removing the protective blanking cover from the top of the drive, the degree of protection for the drive becomes IP21. The protective blanking cover may vary according to the drive model, see opposite.

Specific Recommendations for Mounting in an Enclosure

To help ensure proper air circulation in the drive:

- Fit ventilation grilles.
- Check that there is sufficient ventilation. If there is not, install a forced ventilation unit with a filter. The openings and/or fans must provide a flow rate at least
- Use special filters with UL Type 12/IP54 protection.
- Remove the blanking cover from the top of the drive.

Sealed Metal Enclosure (IP54 Degree of Protection)

The drive must be mounted in a dust and damp proof enclosure in certain environmental conditions, such as dust, corrosive gases, high humidity with risk of condensation and dripping water, splashing liquid, etc. This enables the drive to be used in an enclosure where the maximum internal temperature reaches 50°C.

Recommended Wiring Diagram

3-Phase Power Supply

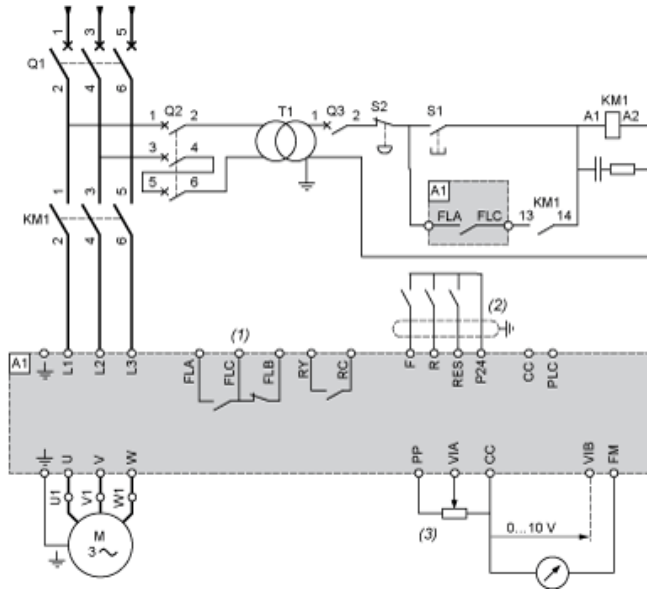

- A1: ATV 212 drive
- KM1: Contactor
- Q1: Circuit breaker
- Q2: GV2 L rated at twice the nominal primary current of T1
- Q3: GB2CB05
- S1, S2: XB4 B or XB5 A pushbuttons
- T1: 100 VA transformer 220 V secondary
- (1) Fault relay contacts for remote signalling of the drive status
- (2) Connection of the common for the logic inputs depends on the positioning of the switch (Source, PLC, Sink)
- (3) Reference potentiometer SZ1RV1202

NOTE: All terminals are located at the bottom of the drive. Install interference suppressors on all inductive circuits near the drive or connected on the same circuit, such as relays, contactors, solenoid valves, fluorescent lighting, etc.

Switches (Factory Settings)

Voltage/current selection for analog I/O (VIA and VIB)



Voltage/current selection for analog I/O (FM)



Selection of logic type

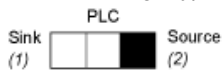

- (1) negative logic
- (2) positive logic

Other Possible Wiring Diagrams

Logic Inputs According to the Position of the Logic Type Switch

“Source” position

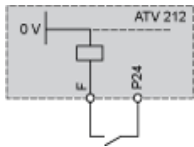

“Sink” position

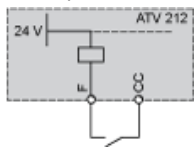

“PLC” position with PLC transistor outputs

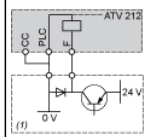

(1) PLC

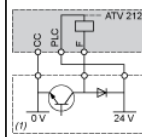

(1) PLC

2-wire control

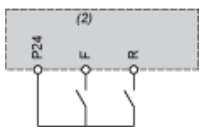

- F: Forward
- R: Preset speed
- (2) ATV 212 control terminals

3-wire control

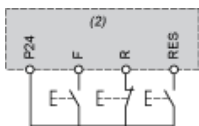

- F: Forward
- R: Stop
- RES: Reverse
- (2) ATV 212 control terminals

PTC probe

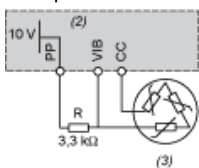

- (2) ATV 212 control terminals
- (3) Motor

Analog Inputs

Voltage analog inputs

External +10 V



Analog input configured for current: 0-20 mA, 4-20 mA, X-Y mA

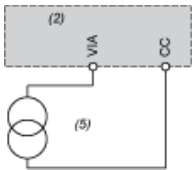

- (2) ATV 212 control terminals
- (5) Source 0-20 mA, 4-20 mA, X-Y mA

Analog input VIA configured as positive logic input ("Source" position)



- (2) ATV 212 control terminals

Analog input VIA configured as negative logic input ("Sink" position)

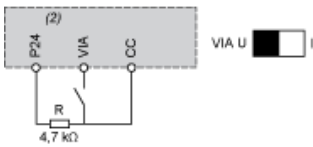

- (2) ATV 212 control terminals

Derating Curves

The derating curves for the drive nominal current (I_n) depend on the temperature, the switching frequency and the mounting type (A, B or C). For intermediate temperatures (45°C for example), interpolate between 2 curves.

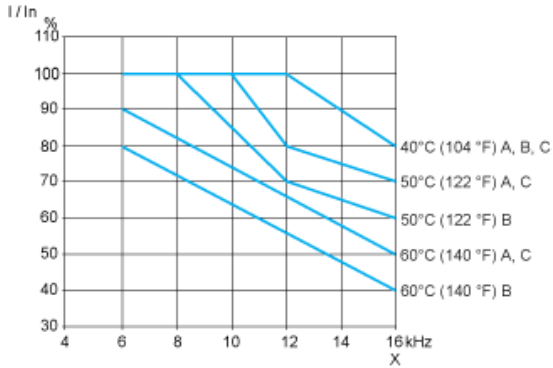

X Switching frequency